

TOYOTA COROLLA MY23

SYSTEM USER MANUAL INFOTAINMENT DIGITAL COCKPIT

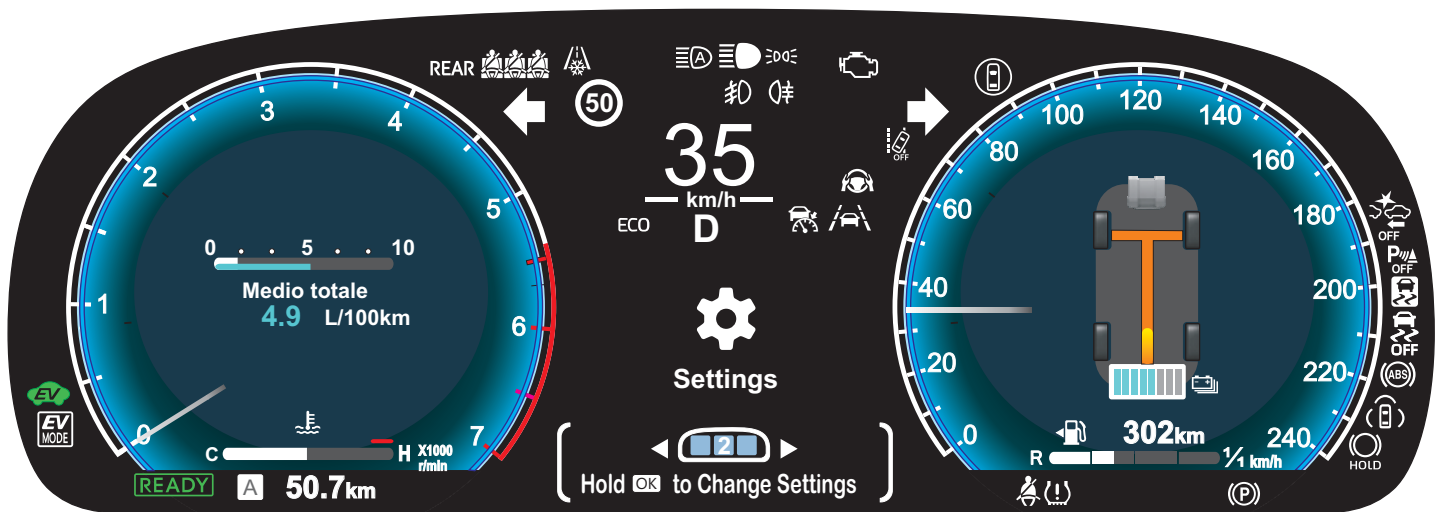





















Digital Cockpit - 12.3 inch



TOYOTA

Safety Sense Version 3.0

TABLE OF CONTENTS

	LDA (Lane Departure Alert) -----	3
	BSM (Blind Spot Monitor) -----	4
	PCS (Pre-Collision System) -----	5
	PDA (Proactive Driving Assist) -----	6
	Parking assist sensor -----	7
	RCTA (Rear Crossing Traffic Alert) -----	8
	PKSB (Parking Support Brake) -----	9
	SEA (Safe Exit Assist) -----	10
	RSA (Road Sign Assist) -----	11
	Vehicle Setting / Break Suggestion -----	12
	DRCC / Speed limiter -----	13
	DRCC / Speed limiter -----	14
	PBD (Power Back Door) -----	15
	TPWS setting (Tyre Pressure Warning System) -----	16
	Meter Setting / Language and Units -----	18
	Dashboard instrument type customization -----	19
	Dynamic radar cruise control -----	27
	Cruise control -----	29
	Speed limiter -----	30
	LTA (Lane Tracing Assist) -----	31



LDA (Lane Departure Alert)

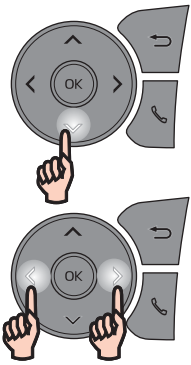

- 1) Press the ↓ key to bring up the settings menu.
- 2) Choose the memory location between 1, 2 or 3 with the → or ← keys to configure the display you want to personalize, then press OK.

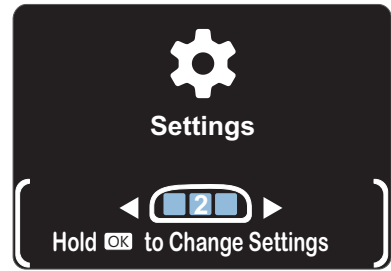

Press the ↓ key to choose LDA and then the OK button to confirm

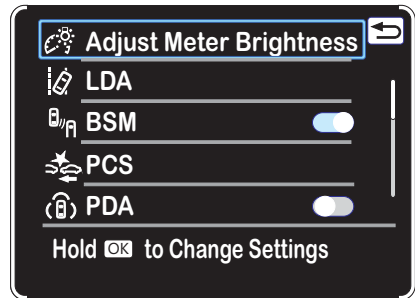

Press the ↓ key to select the line to modify and then OK

- 1) LDA ON/OFF
- 2) Vibration/beeper warning options
- 3) Vibration/beeper warning time

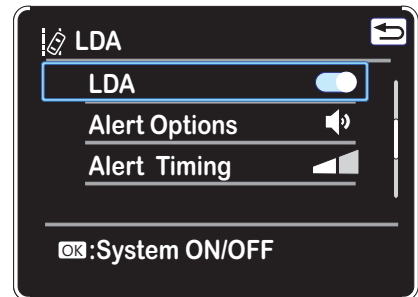

The LDA system warns the driver if the vehicle may deviate from the current lane or course*, and also can slightly operate the steering wheel to help avoid deviation from the lane or course*.

The front camera is used to detect lane lines or a course*.

*: Boundary between the asphalt and grass, soil, etc., or structures, such as a curb, guardrail, etc.

The system is automatically activated every time the power switch is turned ON even if it was previously deactivated.

If LDA is deactivated, the two vertical lines outside the dynamic radar lines disappear and the orange LDA OFF symbol appears.



To exit the settings, press the back button ↶ until you reach the settings menu.



LDA ON

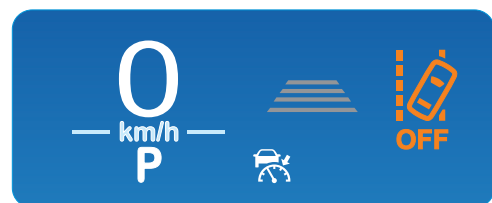

LDA OFF



BSM (Blind Spot Monitor)

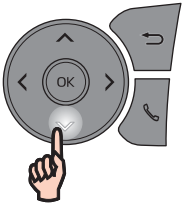

- 1) Press the ↓ key to bring up the settings menu.
- 2) Choose the memory location between 1, 2 or 3 with the → or ← keys to configure the display you want to personalize, then press OK.

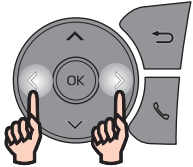

Press the ↓ key to choose BSM and then the OK button for ON/OFF

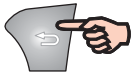
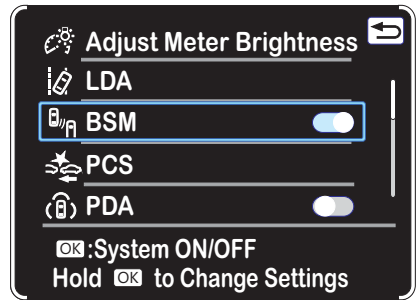
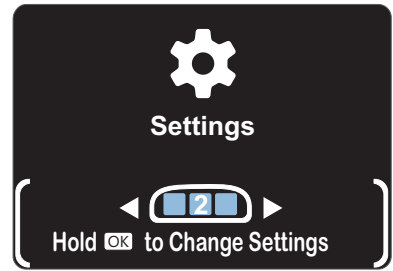

To exit the settings, press the back button ↶ until you reach the settings menu.

The Blind Spot Monitor is a system that uses rear side radar sensors installed on the inner side of the rear bumper on the left and right side to assist the driver in confirming safety when changing lanes.

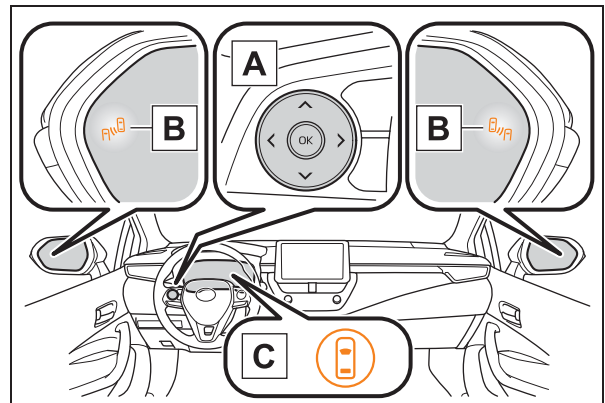

When turn the Blind Spot Monitor OFF a warning box appears and then to exit press the ↶ button.

A Meter control switches

Turning the Blind Spot Monitor on/off.

B Outside rear view mirror indicators

When a vehicle is detected in a blind spot of the outside rear view mirrors or approaching rapidly from behind into a blind spot, the outside rear view mirror indicator on the detected side will illuminate. If the turn signal lever is operated toward the detected side, the outside rear view mirror indicator flashes.

C Driving assist information indicator

Illuminates when the Blind Spot Monitor is turned off. At this time, "Blind Spot Monitor OFF" will be displayed on the multi-information display.



PCS (Pre-Collision System)

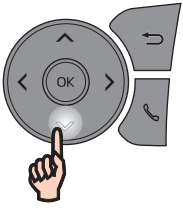

- 1) Press the ↓ key to bring up the settings menu.
- 2) Choose the memory location between 1, 2 or 3 with the → or ← keys to configure the display you want to personalize, then press OK.

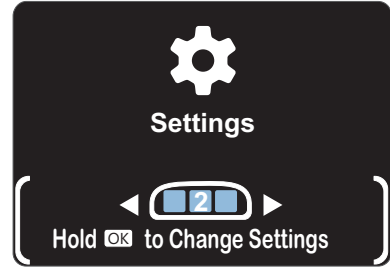
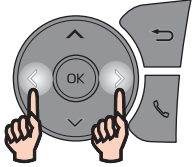

Press the ↓ key to choose PCS and then the OK button to confirm

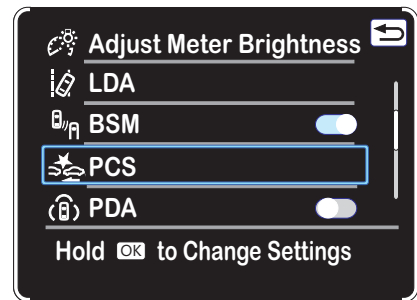

Press the ↓ key to select the line to modify and then OK

- 1) Beeper warning options
- 2) PCS ON/OFF

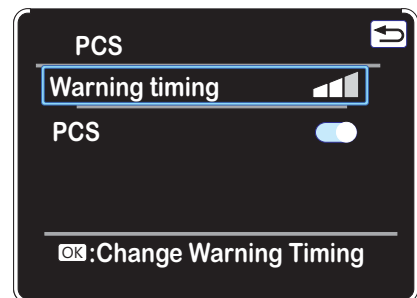

The system is automatically activated every time the power switch is turned ON even if it was previously deactivated



To exit the settings, press the back button ↶ until you reach the settings menu.

The pre-collision system uses sensors to detect objects in the path of the vehicle. When the system determines that the possibility of a frontal collision with a detectable object is high, a warning operates to urge the driver to take evasive action and the potential brake pressure is increased to help the driver avoid the collision. If the system determines that the possibility of a collision is extremely high, the brakes are automatically applied to help avoid the collision or help reduce the impact of the collision. The pre-collision system can be disabled/enabled and the warning timing can be changed.



PDA (Proactive Driving Assist)

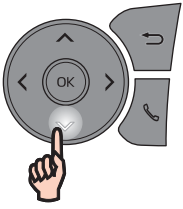

- 1) Press the ↓ key to bring up the settings menu.
- 2) Choose the memory location between 1, 2 or 3 with the → or ← keys to configure the display you want to personalize, then press OK.

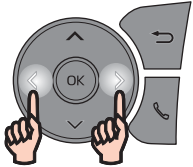

Press the ↓ key to choose PDA and then the OK button for ON/OFF

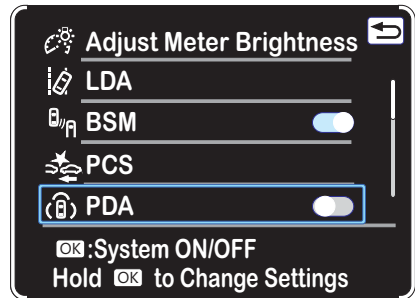
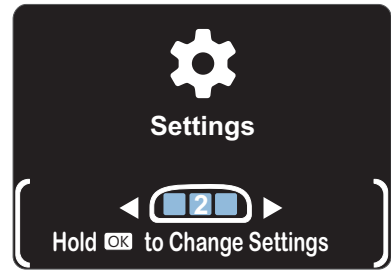

When a detectable object is detected, the proactive driving assist operates the brakes and steering wheel to help prevent the vehicle from approaching too close to the object.

Depending on the situation, the following indicators or icons will be displayed.

Icon	Meaning
	<ul style="list-style-type: none"> • White: Monitoring for detectable objects • Green: Detectable object crossing the road or detectable object on the side of the road assistance operating
	A pedestrian has been detected as crossing the road or on the side of the road and brake or steering assistance is operating
	A vehicle has been detected on the side of the road and brake or steering operation assistance is being performed
	Steering operation assistance is being performed to prevent the vehicle from approaching too close to a detectable object on the side of the road
	Preceding vehicle deceleration assistance is being performed
	Warning to maintain appropriate vehicle-to-vehicle distance
	Curve deceleration assistance is being performed



To exit the settings, press the back button ↶ until you reach the settings menu.



Parking assist sensor

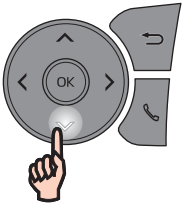

- 1) Press the ↓ key to bring up the settings menu.
- 2) Choose the memory location between 1, 2 or 3 with the → or ← keys to configure the display you want to personalize, then press OK.

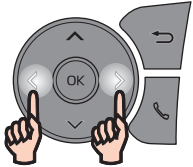

Press the ↓ key to choose and then the OK button for ON/OFF

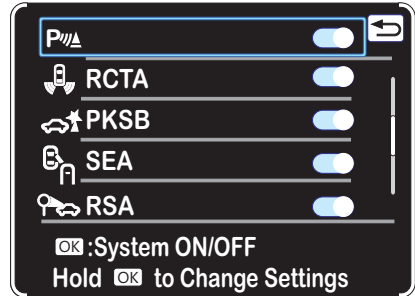
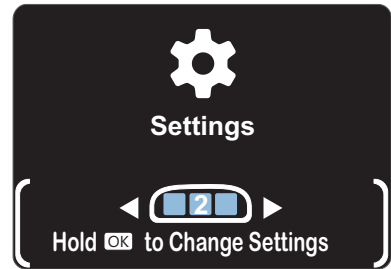

The distance from your vehicle to objects, such as a wall, when parallel parking or maneuvering into a garage is measured by the sensors and communicated via the audio system screen* and a buzzer.

■ The distance and buzzer

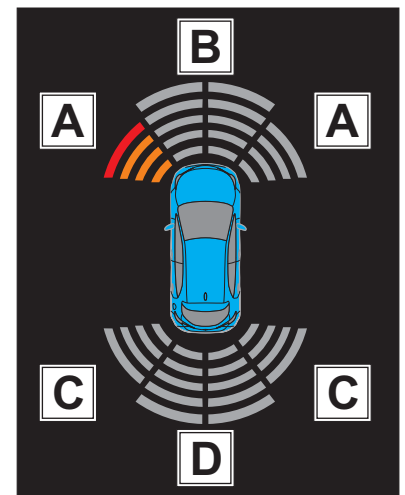
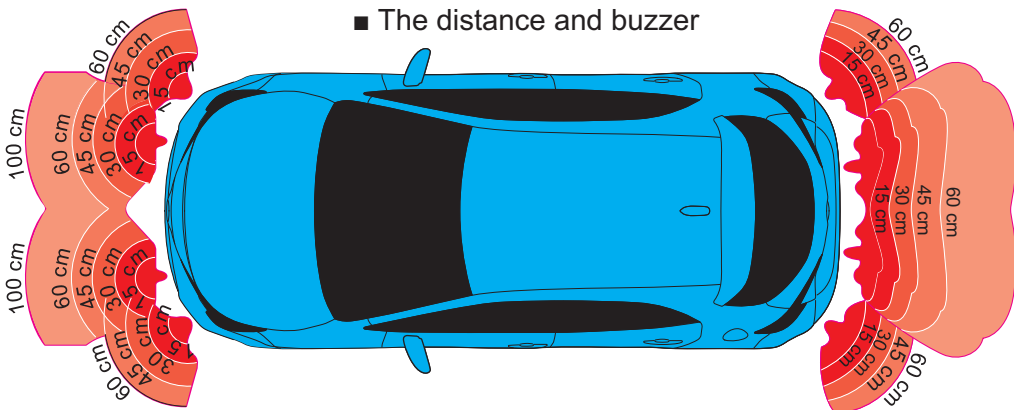

Approximate distance to obstacle	Buzzer
Front center sensor: 100 cm to 60 cm (3.3 ft. to 2.0 ft.)	Slow
Rear center sensor: 150 cm to 60 cm (4.9 ft. to 2.0 ft.)	
60 cm to 45 cm (2.0 ft. to 1.5 ft.)	Medium
45 cm to 30 cm (1.5 ft. to 1.0 ft.)	Fast
30 cm to 15 cm (1.0 ft. to 0.5 ft.)	Continuous
Less than 15 cm (0.5 ft)	

- A** Front corner sensor detection
- B** Front center sensor detection
- C** Rear corner sensor detection
- D** Rear center sensor detection

The system can be operated when

- The power switch is in ON.
- Toyota parking assist-sensor function is on.
- The vehicle speed is less than about 10 km/h (6 mph).
- A shift lever other than P is selected.

The volume of buzzers for the Toyota parking assist-sensor and RCTA function will be adjusted simultaneously.

■ Display

When the sensors detect an object, such as a wall, a graphic is shown on the audio system screen depending on the position and distance to the object.



To exit the settings, press the back button ↶ until you reach the settings menu.



RCTA (Rear Crossing Traffic Alert)

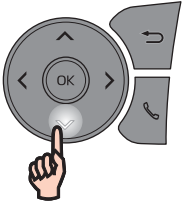

- 1) Press the ↓ key to bring up the settings menu.
- 2) Choose the memory location between 1, 2 or 3 with the → or ← keys to configure the display you want to personalize, then press OK.

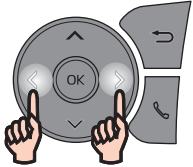

Press the ↓ key to choose RCTA and then the OK button for ON/OFF

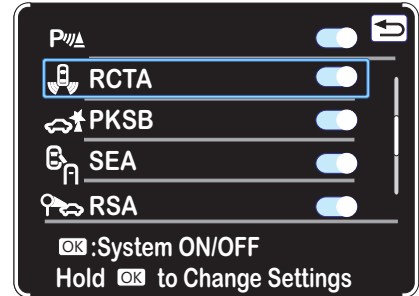
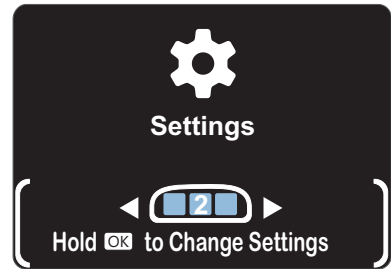

The RCTA function uses the BSM rear side radar sensors to detect vehicles approaching from the right or left at the rear of the vehicle and alerts the driver of the presence of such vehicles by flashing the outside rear view mirror indicators and sounding a buzzer.

A Meter control switches

Operate the meter control switches to enable/disable the RCTA function on the multi-information display.

B Outside rear view mirror indicators

If a vehicle is detected as approaching from the left or right behind the vehicle, both outside rear view mirror indicators will blink and a buzzer will sound.

C Audio system screen

If a vehicle approaching from the right or left at the rear of the vehicle is detected, the RCTA icon for the detected side will be displayed on the audio system screen. This illustration shows an example of a vehicle approaching from both sides of the vehicle.

D Driving assist information indicator

When the RCTA is off, "Rear Cross Traffic Alert OFF" will be displayed on the multi-information display.

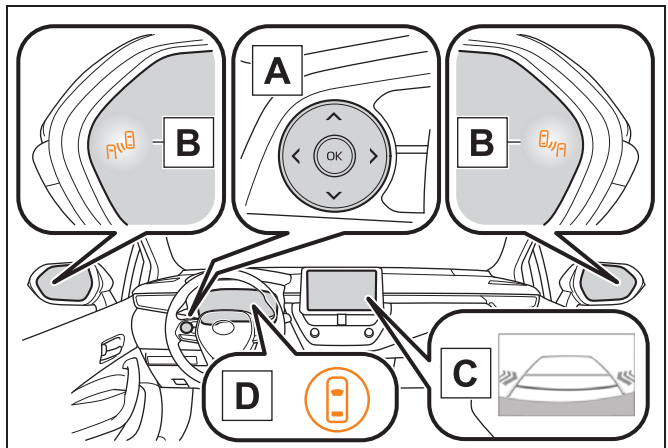

To exit the settings, press the back button ↶ until you reach the settings menu.



PKSB (Parking Support Brake)

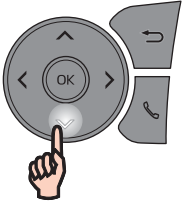

- 1) Press the ↓ key to bring up the settings menu.
- 2) Choose the memory location between 1, 2 or 3 with the → or ← keys to configure the display you want to personalize, then press OK.

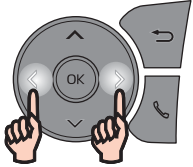

Press the ↓ key to choose PKSB and then the OK button for ON/OFF

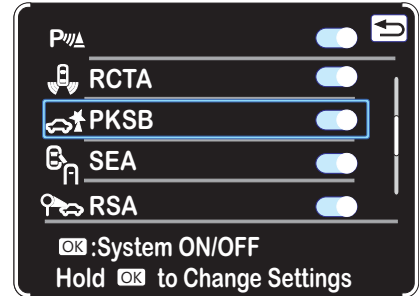
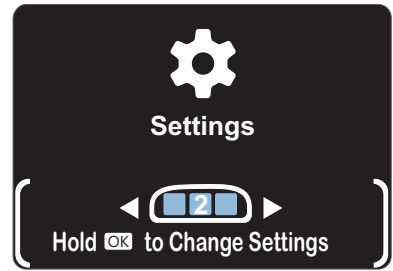

The Parking Support Brake system consists of the following functions that operate when driving at a low speed or backing up, such as when parking. When the system determines that a collision with a detected object is high, a warning operates to urge the driver to take evasive action. If the system determines that the possibility of a collision with a detected object is extremely high, the brakes are automatically applied to help avoid the collision or help reduce the impact of the collision.

■ **Parking Support Brake function (static objects)**
Ultrasonic sensors are used to detect static objects, such as a wall, in the detection area when driving at a low speed or backing up.

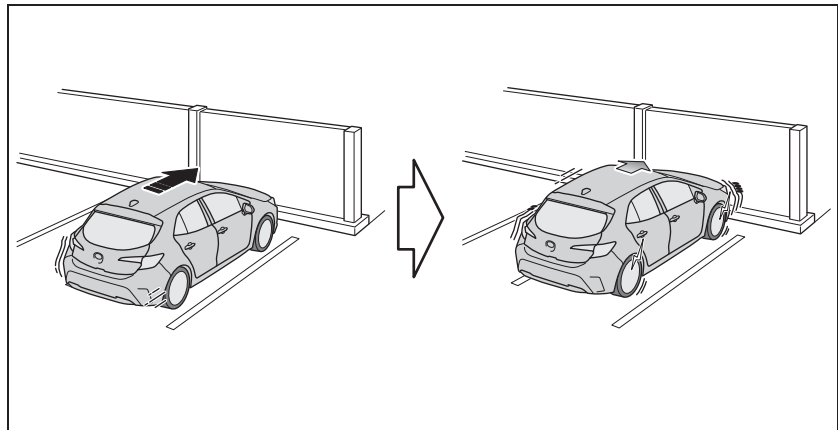

■ **Parking Support Brake function (rear-crossing vehicles) (if equipped)**
Rear radar sensors are used to detect approaching vehicles in the detection area behind the vehicle when backing up.

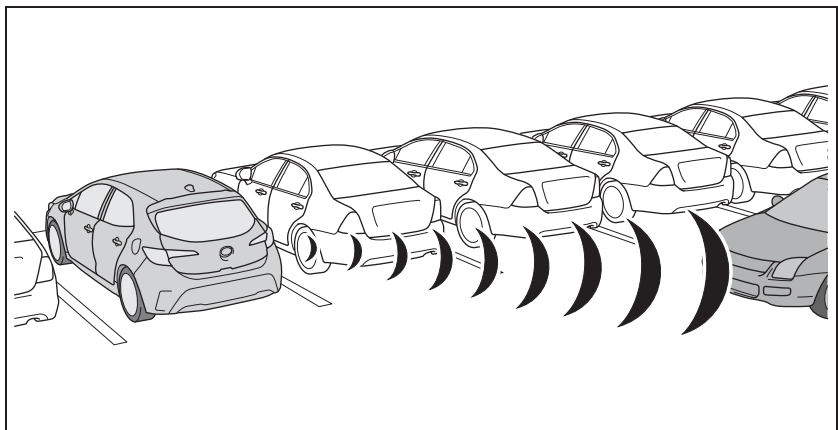

To exit the settings, press the back button ↶ until you reach the settings menu.



SEA (Safe Exit Assist)

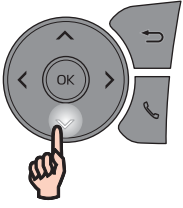

- 1) Press the ↓ key to bring up the settings menu.
- 2) Choose the memory location between 1, 2 or 3 with the → or ← keys to configure the display you want to personalize, then press OK.

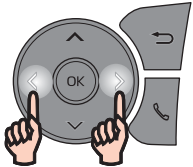

Press the ↓ key to choose SEA and then the OK button for ON/OFF

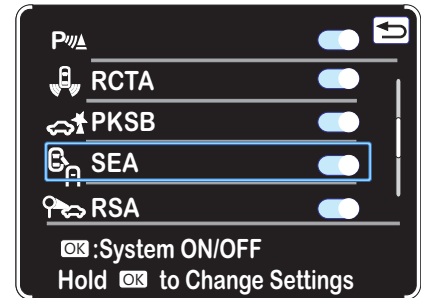
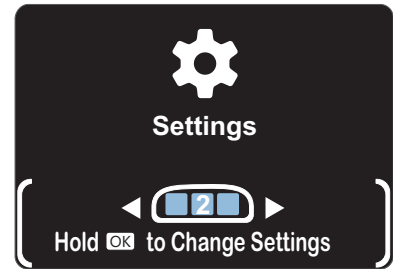

The safe exit assist is a system that uses rear side radar sensors installed on the inner side of the rear bumper to help occupants judge if an approaching vehicle or bicycle may collide with a door when opening it or cancel opening of the door, to reduce the possibility of a collision.

A Multi-information display

Turning the safe exit assist on/off. When the system determines that the possibility of a collision with a door is high, the target door is displayed on the multi-information display. Also, if the door is opened when the outside rear view mirror indicator is illuminated, a buzzer will sound as a warning.

B Outside rear view mirror indicators When a vehicle or bicycle which may collide with a door (other than the back door) when opened is detected, the outside rear view mirror indicator on the detected side will illuminate. When a door on the detected side is opened, the outside rear view mirror indicator will flash.

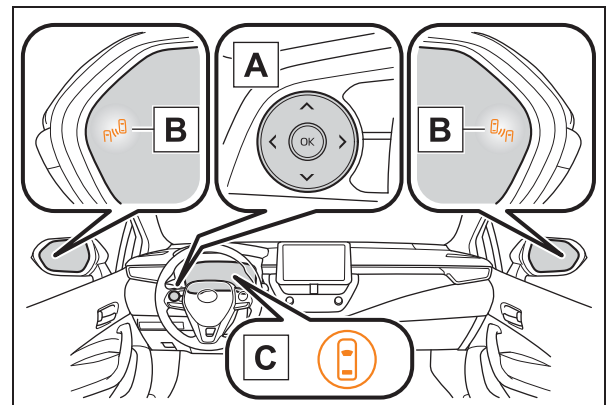

C Driving assist information indicator Illuminates when the safe exit assist is turned off. At this time, "Safe Exit Assist OFF" will be displayed on the multi-information display.

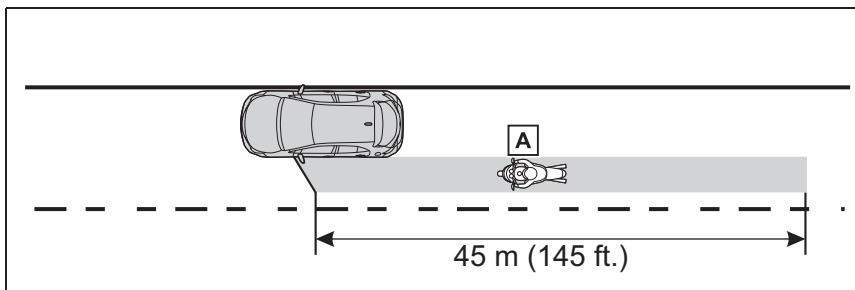

Approximately 45 m (145 ft.)
Rearward from the front door

A Vehicle or bicycle which has a high possibility of colliding with a door (other than the back door) when opened

The system is automatically activated every time the power switch is turned ON even if it was previously deactivated



To exit the settings, press the back button ↶ until you reach the settings menu.



RSA (Road Sign Assist)

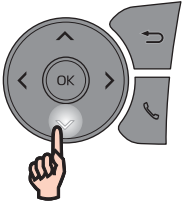

- 1) Press the ↓ key to bring up the settings menu.
- 2) Choose the memory location between 1, 2 or 3 with the → or ← keys to configure the display you want to personalize, then press OK.

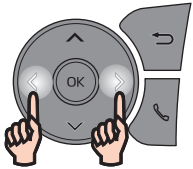

Press the ↓ key to choose RSA and then the OK button for ON/OFF

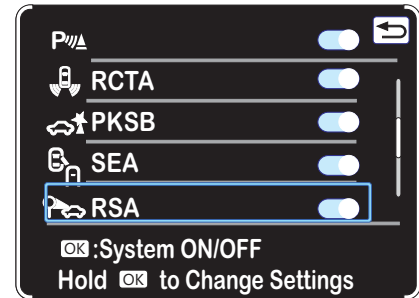
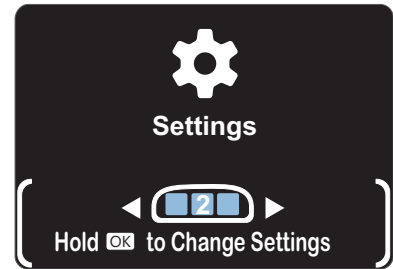

The RSA system detects specific road signs using the front camera and/or navigation system (when speed limit information is available) and warns the driver via displays and buzzers.

In the following situations, the RSA system will output a warning to notify the driver.

- If the vehicle speed exceeds the speed warning threshold of the speed limit sign displayed on the display, the sign display will be emphasized and a buzzer will sound.
- When the RSA system detects a no-entry sign and determines that the vehicle has entered the no-entry area based on the map information of the navigation system, the no-entry sign displayed on the multi-information display will flash and a buzzer will sound. (vehicles with a navigation system)

The following types of road signs can be displayed.

However, non-standard or recently introduced traffic signs may not be displayed.

Speed limit	No speed limit info.	Zebra crossing	Residential area
No overtaking	Residential area	Stop	Urban area
Motorway	Men at work	Rain	Ice
Expressway	No-entry	Wet	Supplemental mark exists
Speed limit with supplemental mark			



To exit the settings, press the back button ↵ until you reach the settings menu.



Vehicle Setting / Break Suggestion

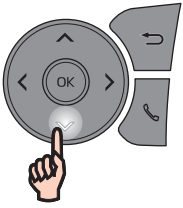

- 1) Press the ↓ key to bring up the settings menu.
- 2) Choose the memory location between 1, 2 or 3 with the → or ← keys to configure the display you want to personalize, then press OK.

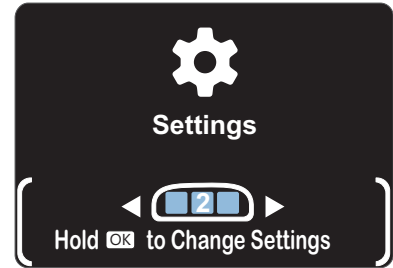
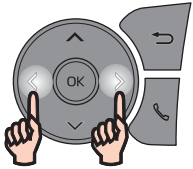

Press the ↓ key to choose Vehicle Settings and then the OK button to change settings

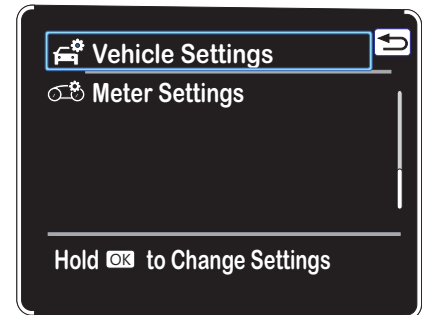

Press the ↓ key to choose Break Suggestion and then the OK button for ON/OFF

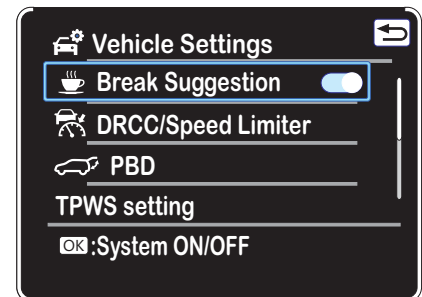

If you drive for at least 4 hours without stopping, a message will be displayed and a warning buzzer will sound to urge the driver to take a break.

Also if the vehicle is swaying, a message will be displayed and a warning buzzer will sound to urge the driver to take a break.



To exit the settings, press the back button ↶ until you reach the settings menu.



DRCC / Speed limiter

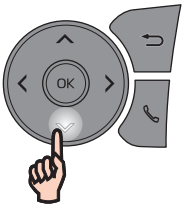

- 1) Press the ↓ key to bring up the settings menu.
- 2) Choose the memory location between 1, 2 or 3 with the → or ← keys to configure the display you want to personalize, then press OK.

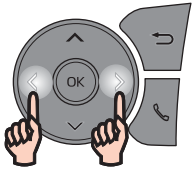

Press the ↓ key to choose DRCC/Speed Limiter and then the OK button to change settings

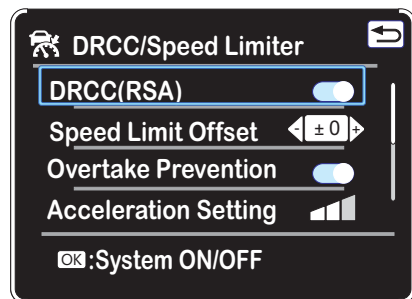
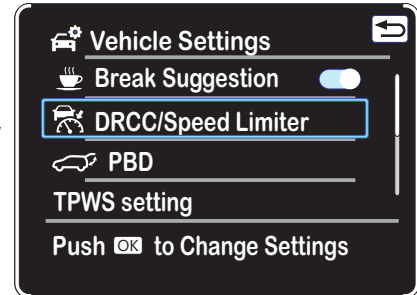
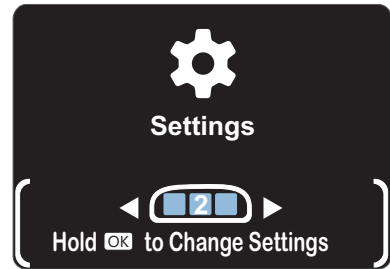

DRCC(RSA) allows you to (almost) automatically adjust the speed (with active "cruise control" or "Speed Limiter") to that indicated by the detected road signs. The "almost" is because you need to confirm the warning that appears in the box that you want to increase or decrease the speed with "+ RES" or "-" respectively.

If you have RSA (Road Sign Assist) enabled, when you go with the radar cruise to 30 km/h, for example when you are driving your car and the system detects a signal of 50 km/h on the dashboard, the signal of 50 km/h appears surrounded by a green color with an up ▲ or down ▼ arrow, if you press +RES for 2 seconds the car automatically increases the speed up to 50 km/h (the same for reducing the speed but with "-" push button).

When the set vehicle speed is lower than the detected speed limit
Press and hold the "+RES" switch

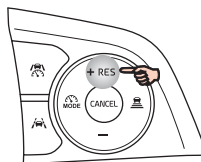

When the set vehicle speed is higher than the detected speed limit
Press and hold the "-" switch

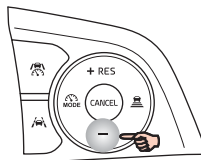

As soon as a speed limit sign is detected, a warning appears for a few seconds in the central sector



To exit the settings, press the back button ↶ until you reach the settings menu.



DRCC / Speed limiter

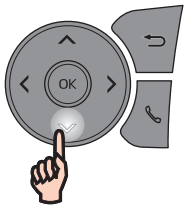

- 1) Press the ↓ key to bring up the settings menu.
- 2) Choose the memory location between 1, 2 or 3 with the → or ← keys to configure the display you want to personalize, then press OK.

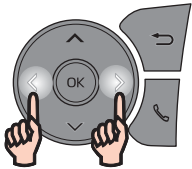

Press the ↓ key to choose DRCC/Speed Limiter and then the OK button to change settings

Curve speed reduction function

When a curve is detected, the vehicle speed will begin being reduced.

When the curve ends, the vehicle speed reduction will end. Depending on the situation, the vehicle speed will then return to the set vehicle speed.

In situations where vehicle-to-vehicle distance control needs to operate, such as when a preceding vehicle cuts in front of your vehicle, the curve speed reduction function will be canceled.



■ Situations in which the curve speed reduction function may not operate In situations such as the following, the curve speed reduction function may no operate:

- When the vehicle is being driven around a gentle curve
- When the accelerator pedal is being depressed
- When the vehicle is being driven around an extremely short curve

Overtaking prevention function

If a detected vehicle in the passing lane is traveling slower than your vehicle, overtaking will be suppressed.

The overtaking prevention function will not operate if the passing lane is congested or vehicles are traveling at low speeds.

This function is not available for vehicles without a DCM.

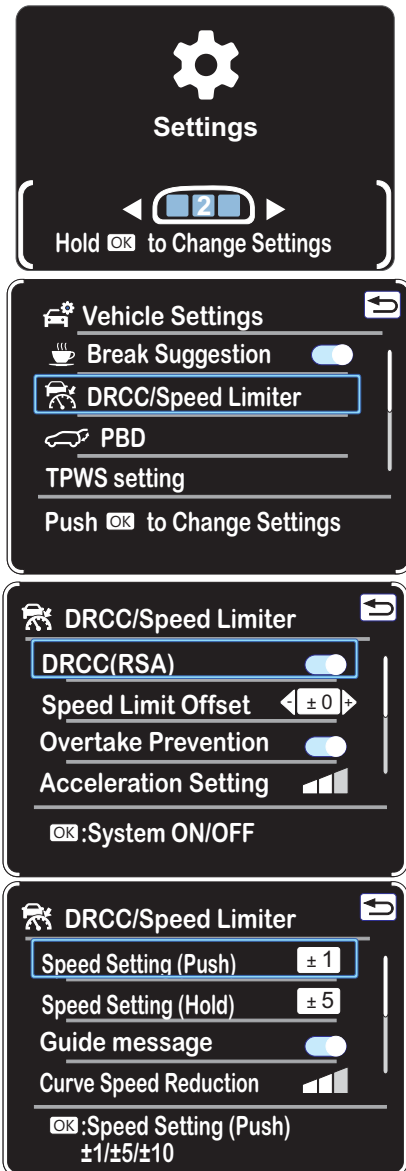

DRCC/Speed Limiter setting	Change Setting
Overtake prevention	On, Off
Acceleration setting	High, Mid, Low
Speed setting (short press)	1 mph, 5 mph, 10 mph)
Speed setting (long press)	1 mph, 5 mph, 10 mph
Dynamic Radar Cruise Control with Road Sign Assist	On, Off
Speed limit offset	-5 to +5
Guide message	On, Off
Curve speed reduction	High, Mid, Low, Off



To exit the settings, press the back button ↶ until you reach the settings menu.



PBD (Power Back Door)

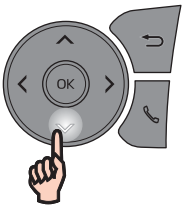

- 1) Press the ↓ key to bring up the settings menu.
- 2) Choose the memory location between 1, 2 or 3 with the → or ← keys to configure the display you want to personalize, then press OK.

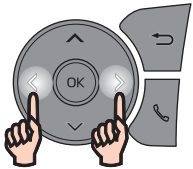
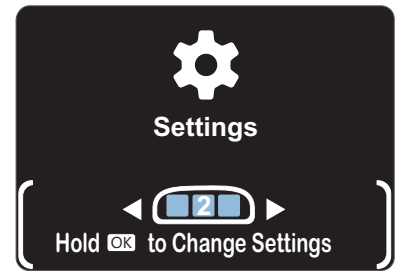

Press the ↓ key to choose PBD and then the OK push button to change settings

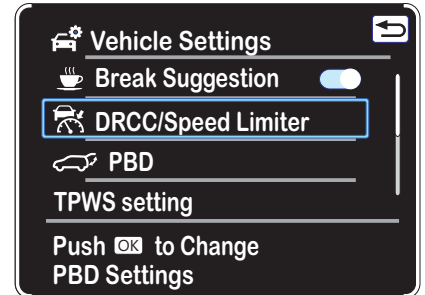

Press the ↓ key to choose  and then the OK push button for ON/OFF

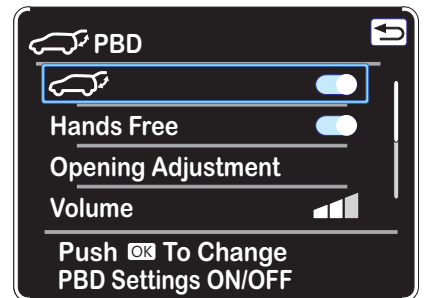

Press the ↓ key to choose Opening Adjustment and then the OK push button to change settings

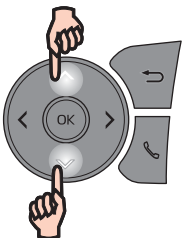
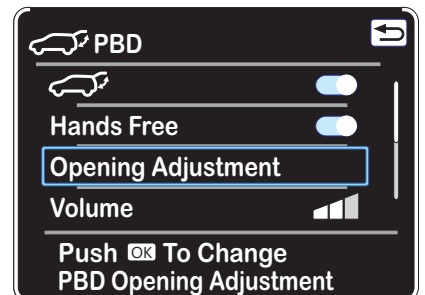

Press the ↑ or ↓ button to adjust the opening Back Door from 1 to 5 stop position and then the OK button to confirm.

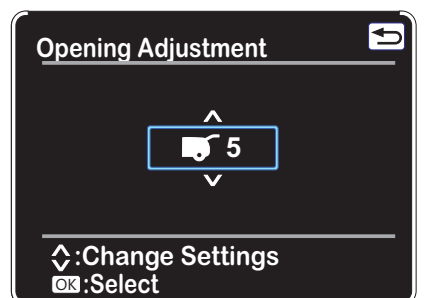

To exit the settings, press the back button ↶ until you reach the settings menu.



TPWS Setting (Tyre Pressure Warning System)

When replacing tires or wheels, tire pressure warning valves and transmitters must also be installed.

When new tire pressure warning valves and transmitters are installed, new ID codes must be registered in the tire pressure warning computer and the tire pressure warning system must be initialized.

- 1) Park the vehicle in a safe place and turn the power switch off, wait for approximately 20 minutes or more, and then start the hybrid system. The ID code registration procedure cannot be performed while the vehicle is moving.
- 2) Select  of the multi-information display and then press OK.
- 3) Press \uparrow or \downarrow to select "Vehicle Settings" and then hold OK.
- 4) Press \uparrow or \downarrow to select "TPWS setting" and then press OK.
- 5) Press \uparrow or \downarrow to select "Tire Set Switching" and then press OK.
- 6) Press \uparrow or \downarrow to select "Register New Valve/ID" and then press OK.
- 7) Press \uparrow or \downarrow to select "Tire Set 1" or "Tire Set 2". Then press OK. ID codes will be registered to the displayed wheel set.

Registration of the position of each wheel after performing a tire rotation

- 1 - Park the vehicle in a safe place and turn the power switch off, wait for approximately 20 minutes or more, and then start the hybrid system. The wheel position registration procedure cannot be performed while the vehicle is moving.
- 2 - Select  of the multi-information display and then press .
- 3 - Press \uparrow or \downarrow to select "Vehicle Settings" and then press and hold.
- 4 - Press \uparrow or \downarrow to select "TPWS setting" and then press.
- 5 - Press \uparrow or \downarrow to select "Tire Rotation" and then press.
- 6 - Select "OK" and then press OK. A message indicating that wheel position registration is being performed will be displayed on the multi-information display. "---" will be displayed for the tire inflation pressure of each tire and wheel position registration will begin.
- 7 - Drive straight (with occasional left and right turns) at approximately 40 km/h (25 mph) or more for approximately 10 to 30 minutes.

When wheel position registration is complete, a message indicating that registration has been completed and the inflation pressure of each tire will be displayed on the multi-information display.

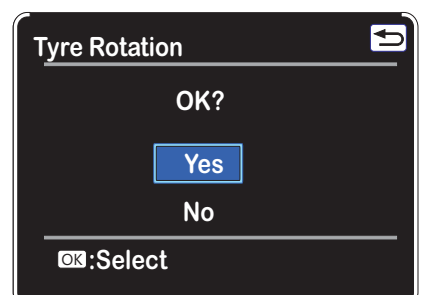
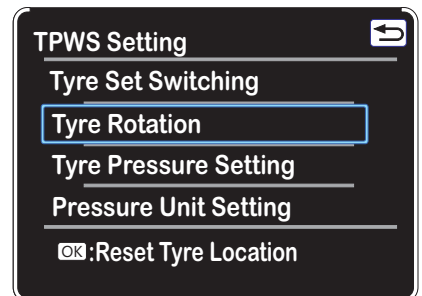
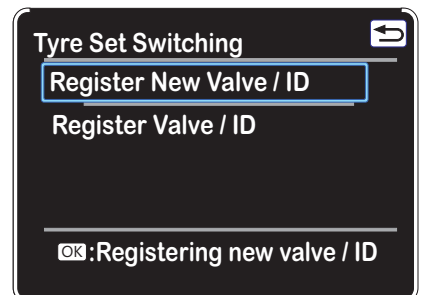
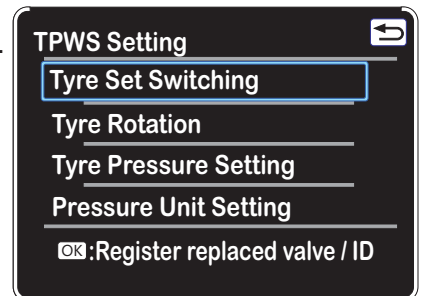
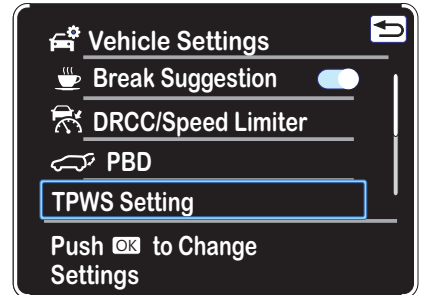
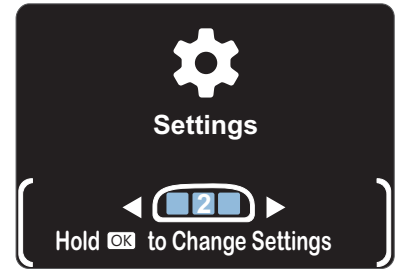



TPWS Setting

If the tire inflation pressure has been adjusted to the specified level, perform the tire inflation setting procedure by selecting specified inflation pressure on the multi-information display.

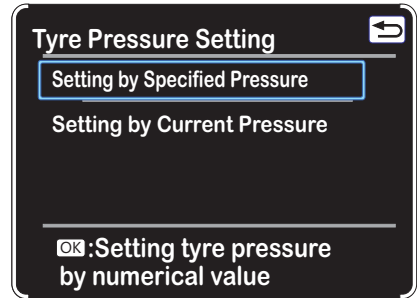
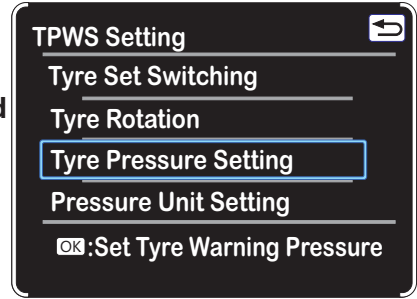

You can choose between 3 tire inflation values

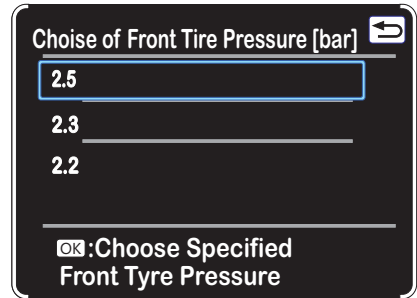

If the value is not between standard values, you can inflate the tires to the customized value and then choose "setting by Current Pressure", select Yes and OK to confirm.

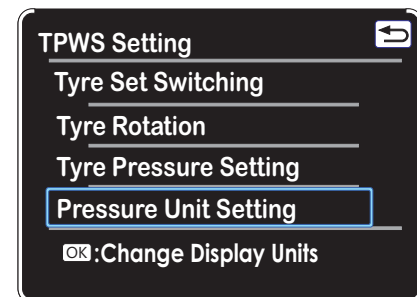
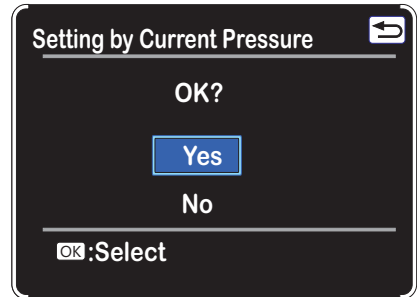

You can choose the pressure unit setting, after selecting confirm with OK.

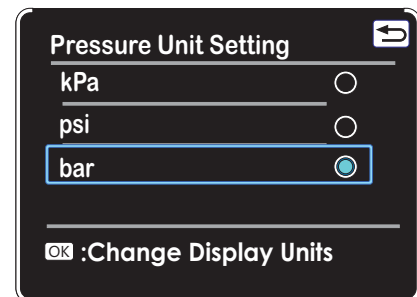



Meter Setting / Language and Units

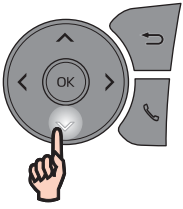

- 1) Press the ↓ key to bring up the settings menu.
- 2) Choose the memory location between 1, 2 or 3 with the → or ← keys to configure the display you want to personalize, then press OK.

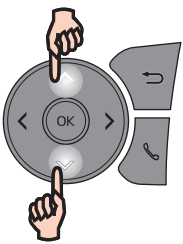
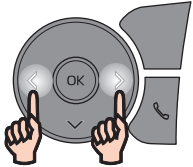

Press the ↑ or ↓ key to choose Meter Settings and then the OK push button to Change Settings

Press the ↑ or ↓ key to choose Language and then the OK push button to confirm

Press the ↑ or ↓ key to select Language and then the OK push button to confirm

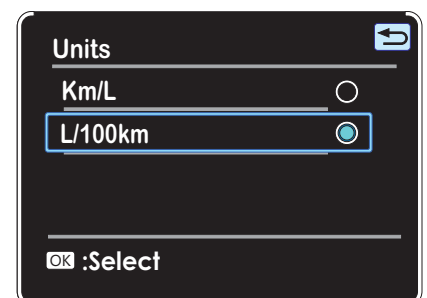
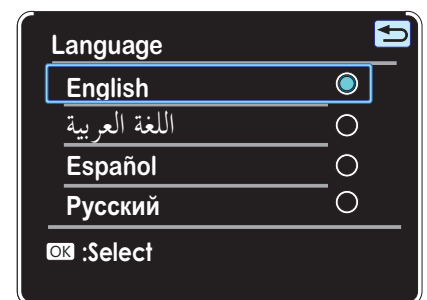
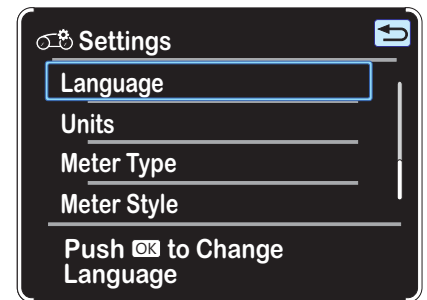
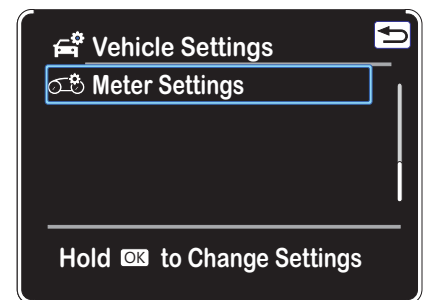
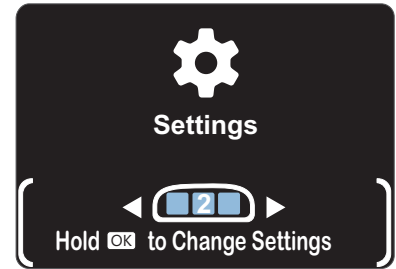

Press the ↑ or ↓ button to choose Unit and then between Km/L and L/100km, confirm with the OK button.





Dashboard instrument type customization

You can choose from three types of display faces

- 1) Without dials (Digital Speedometer only) 
 - 2) 1 dial (12 variations) 
 - 3) 2 dials (8 variations) 
- Total 21 variations

Press the ↑ or ↓ button to choose Instrumentation type and then push the OK button to confirm.

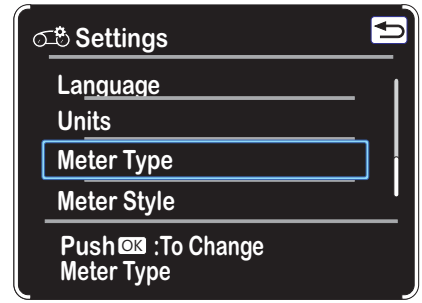

1

Only Digital Speedometer

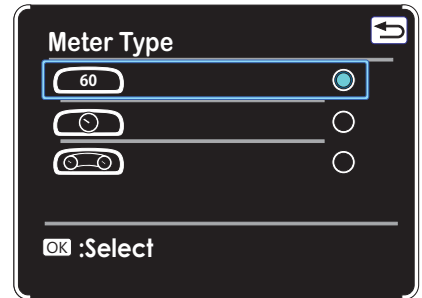
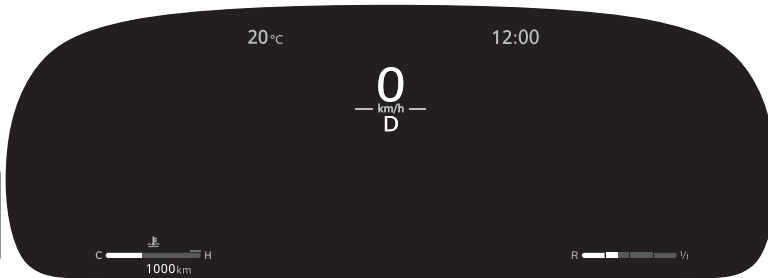

1 dial variant

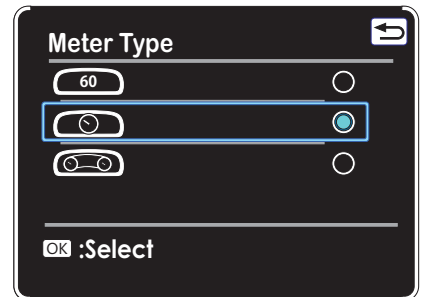
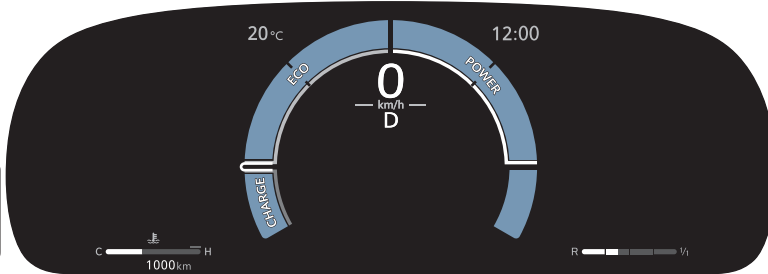

Hibrid System

2 dial variant

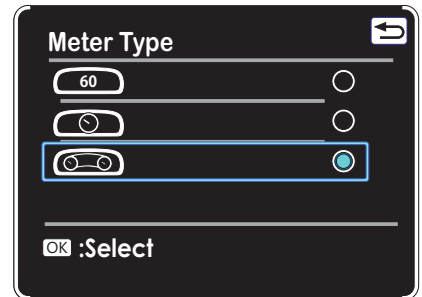
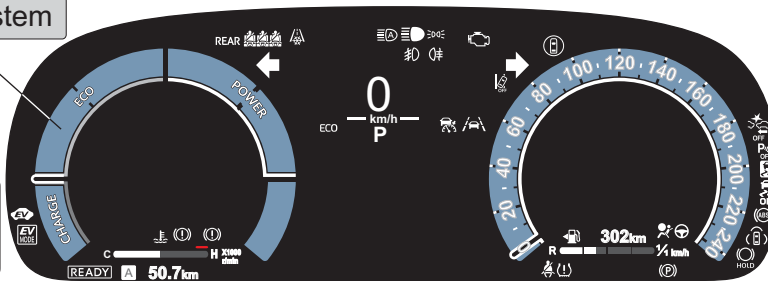

Press the back button ↵ then press the ↓ button until "Meter type" is selected to choose between tachometer or hybrid system

Tachometer

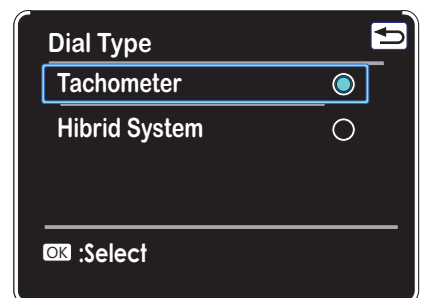
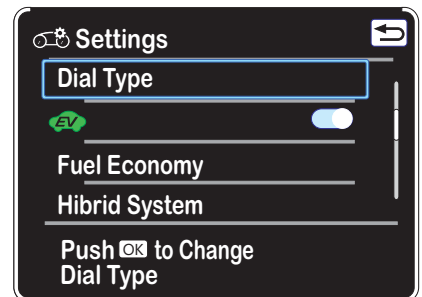
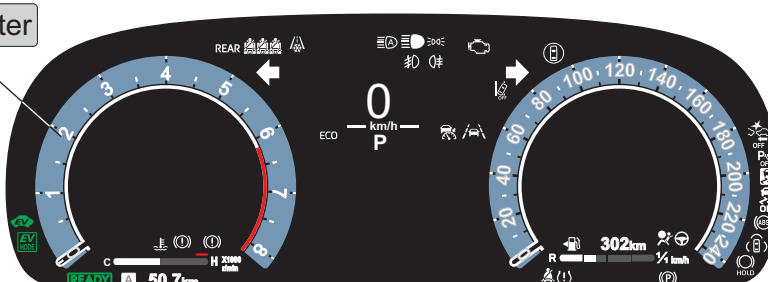



Dashboard instrument type customization



When you choose the single-dial layout, you can add consumption information to the left sector and information about the radio channel being listened to on the right sector via the "Widget" selection.

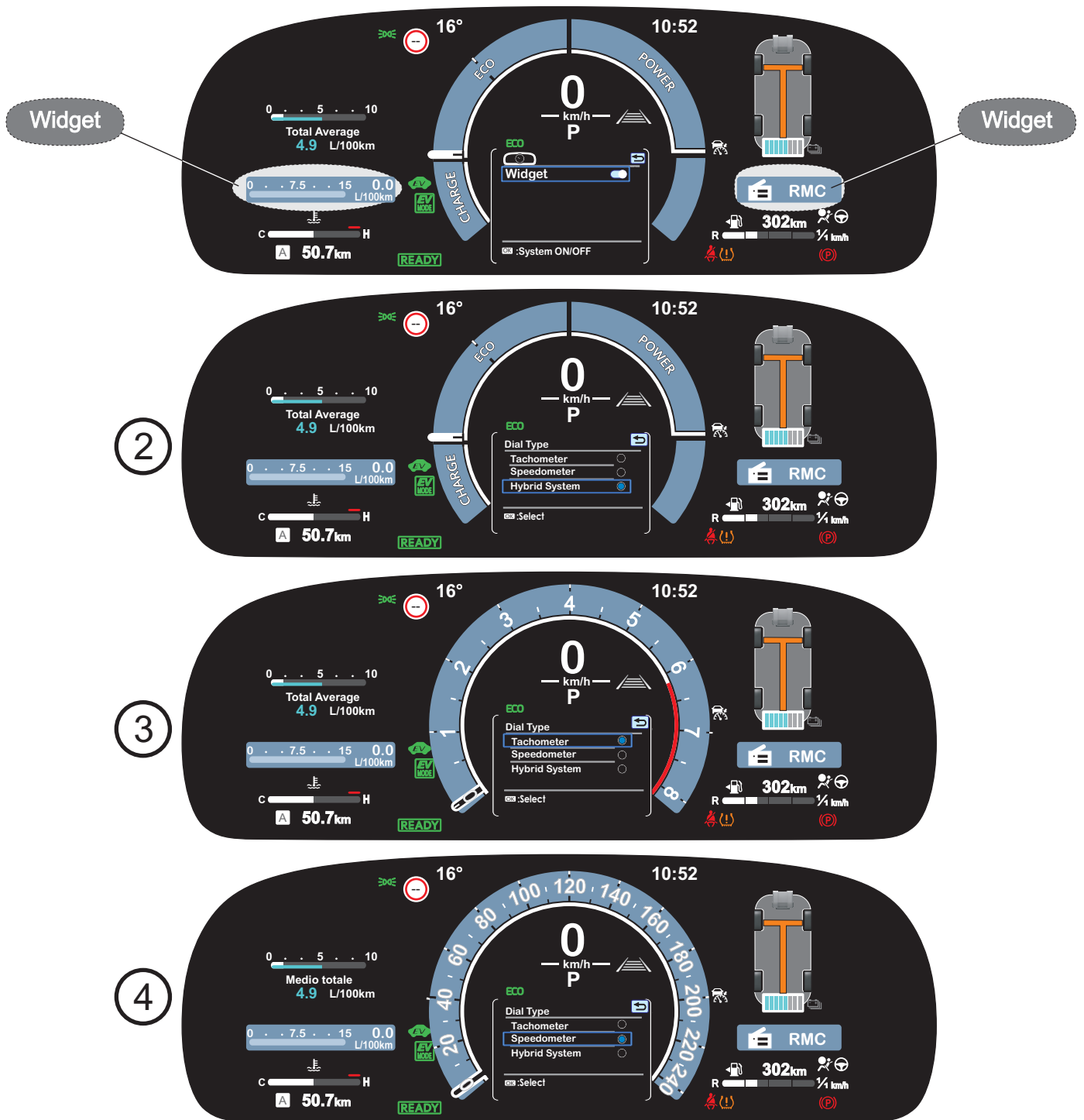



Dashboard instrument type customization

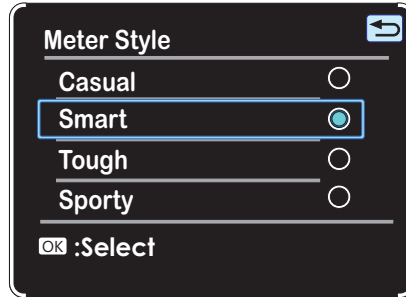

5

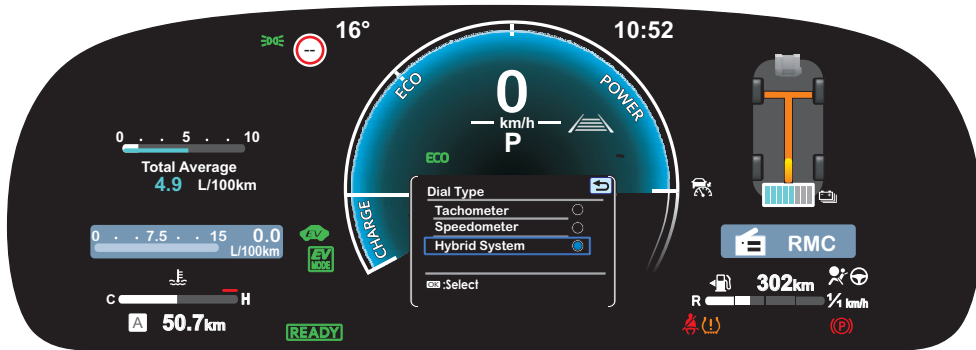

6

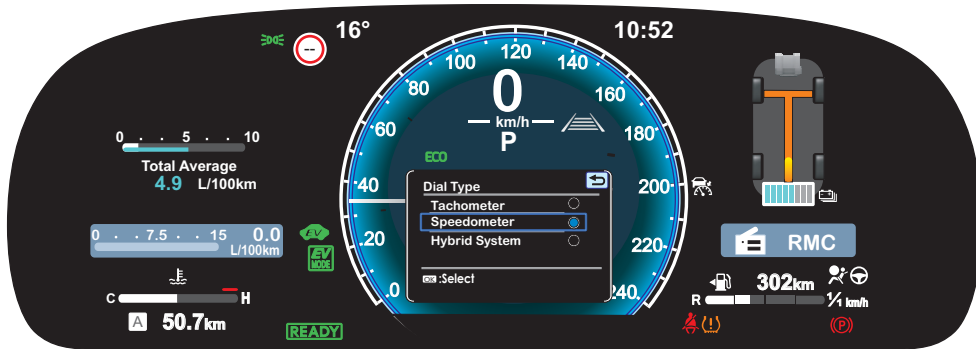

7

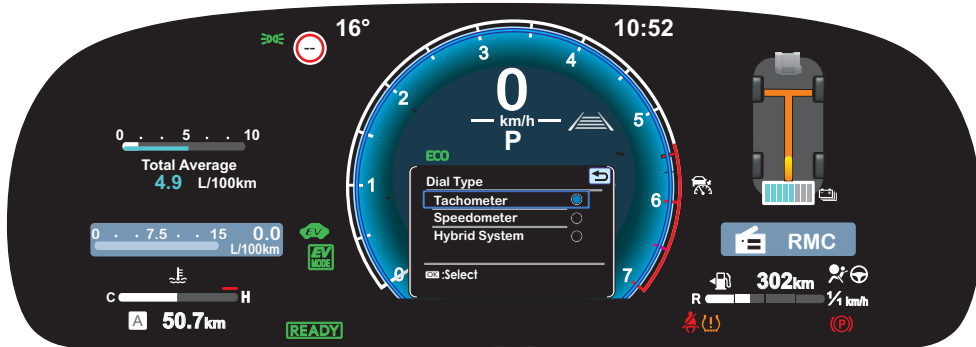



Dashboard instrument type customization

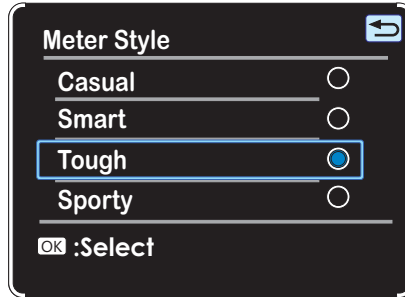

8

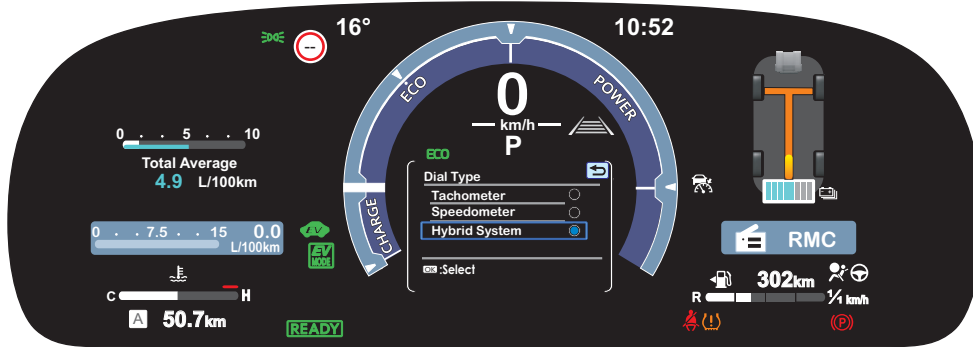

9

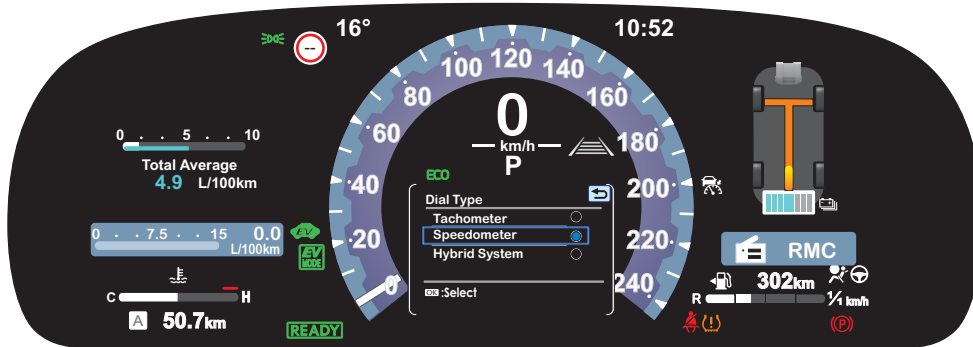

10

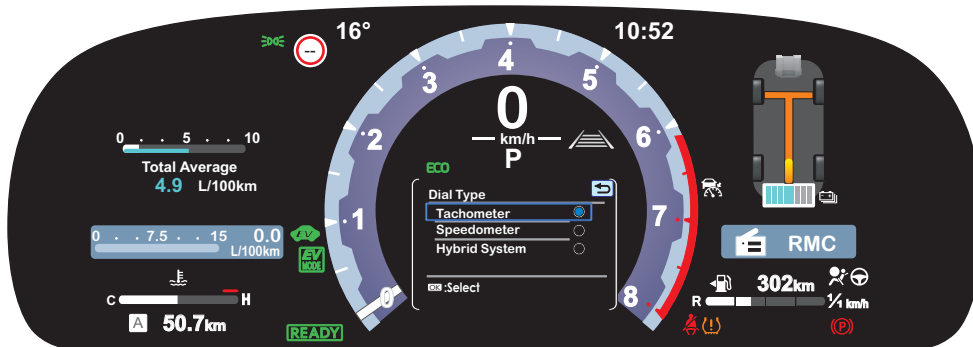



Dashboard instrument type customization

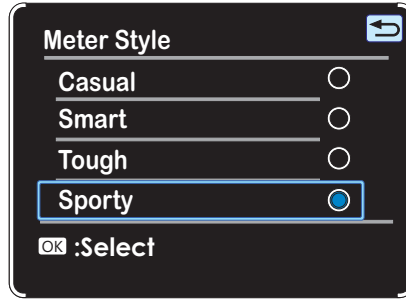

11

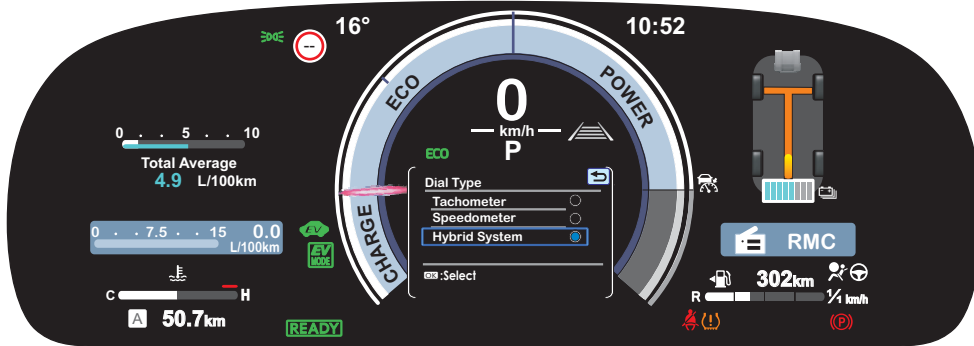

12

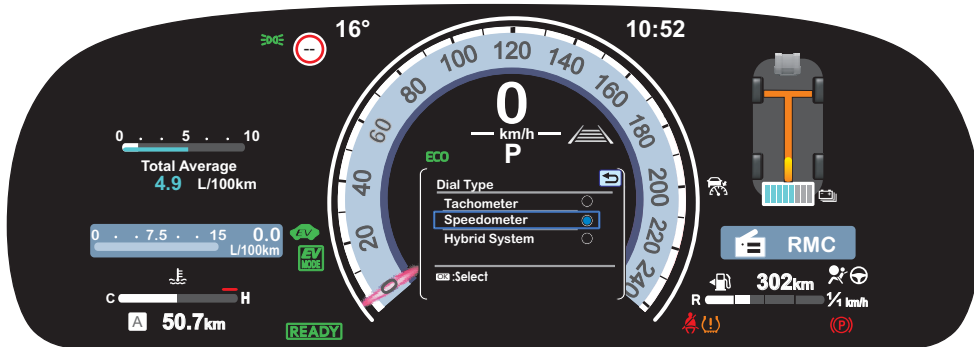

13

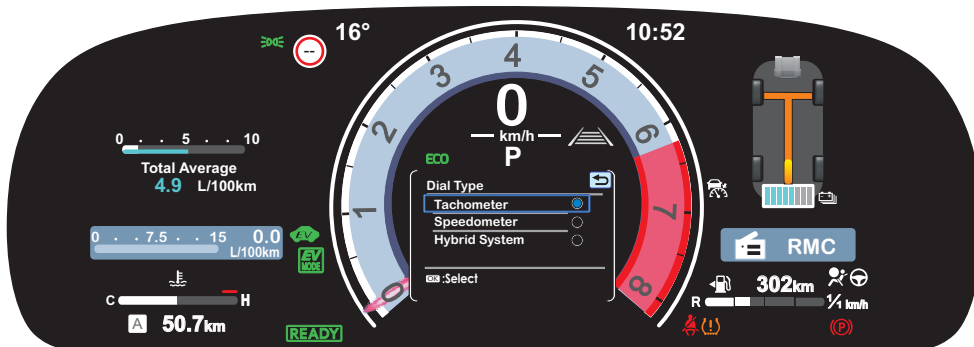



Dashboard instrument type customization

It is possible to choose between four instrumentation models with "Tachometer".

- 1) Casual
- 2) Smart
- 3) Tough
- 4) Sparty

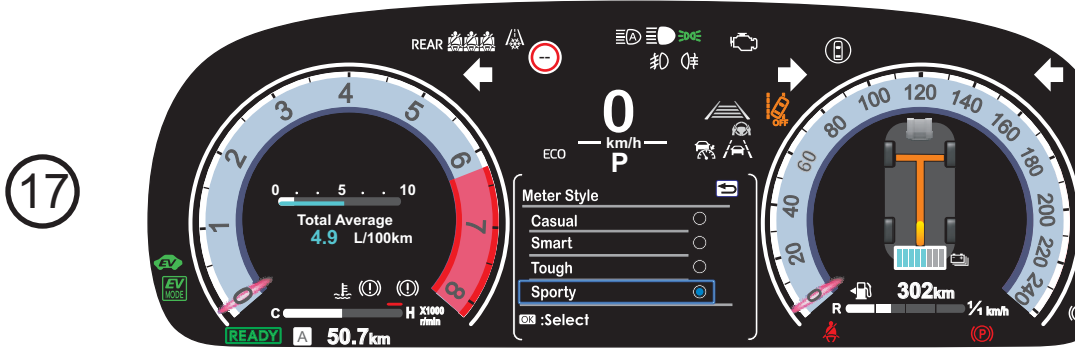
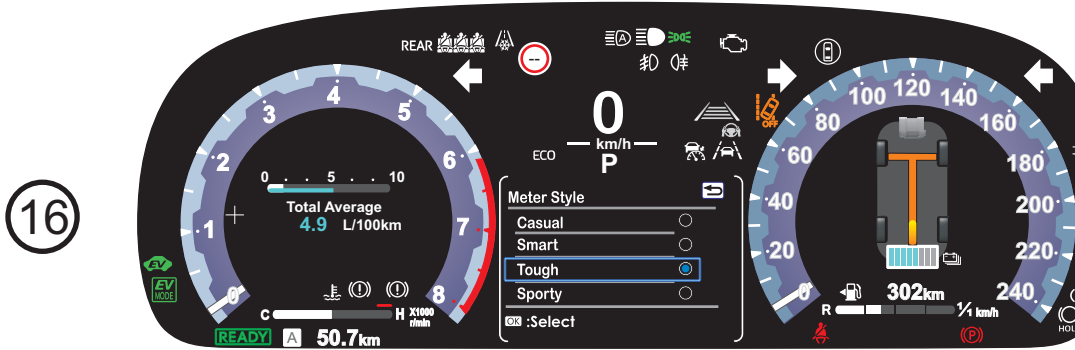
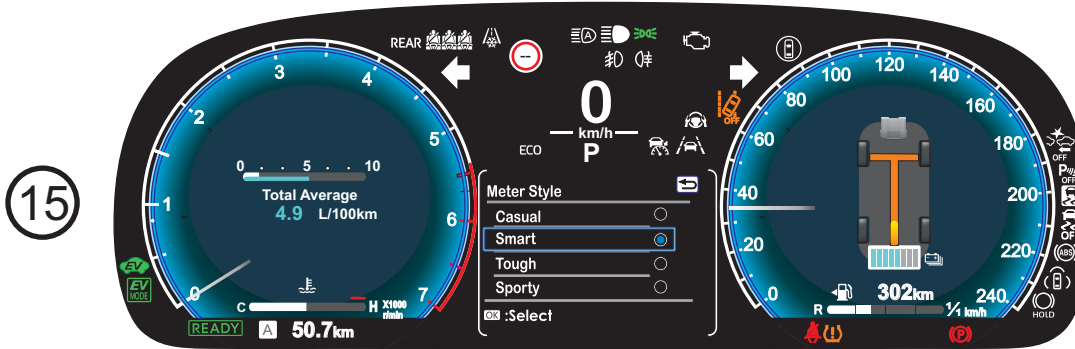
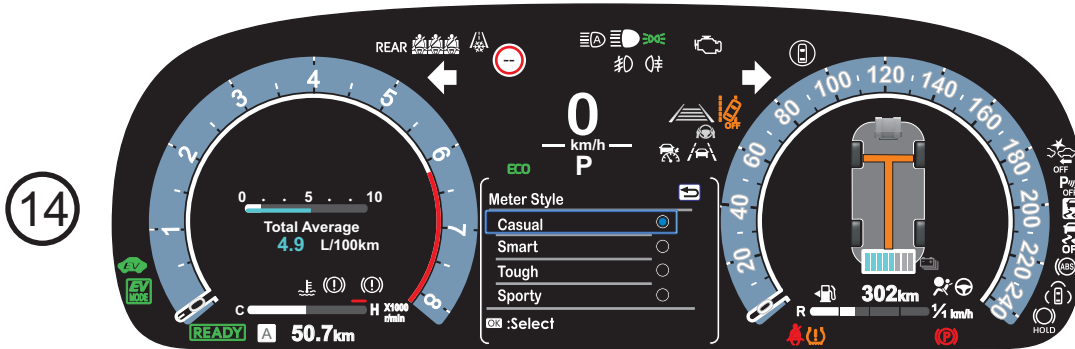
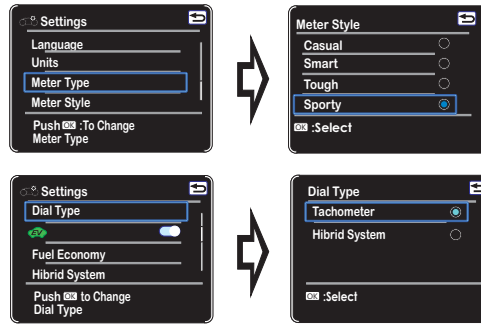



Dashboard instrument type customization

It is possible to choose between four instrumentation models with "Hibrid System".

- 1) Casual
- 2) Smart
- 3) Tough
- 4) Sparty

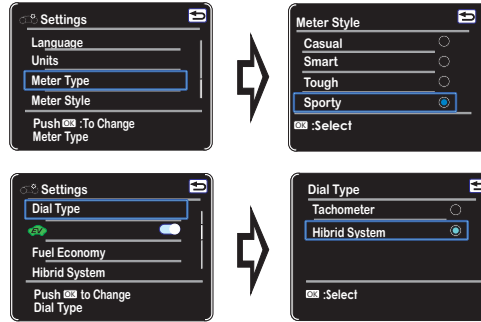

18

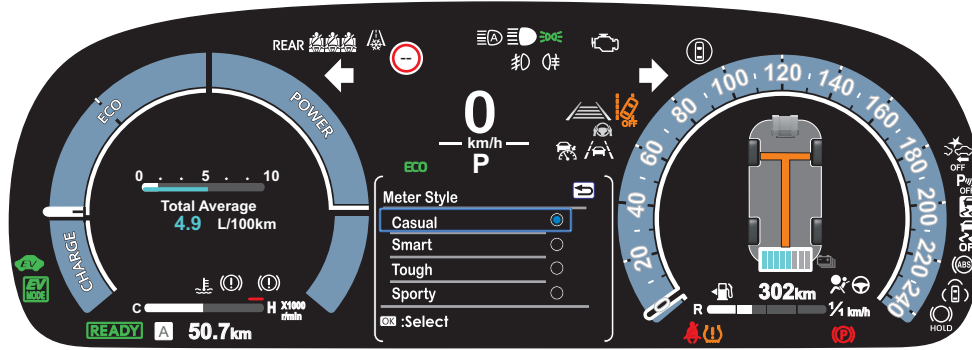

19

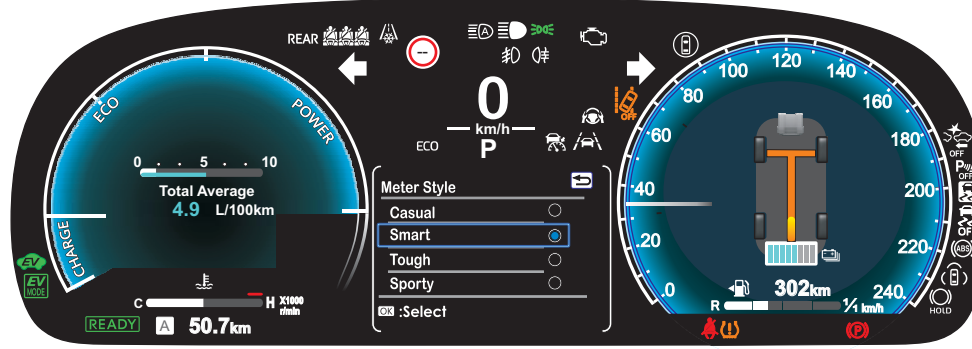

20

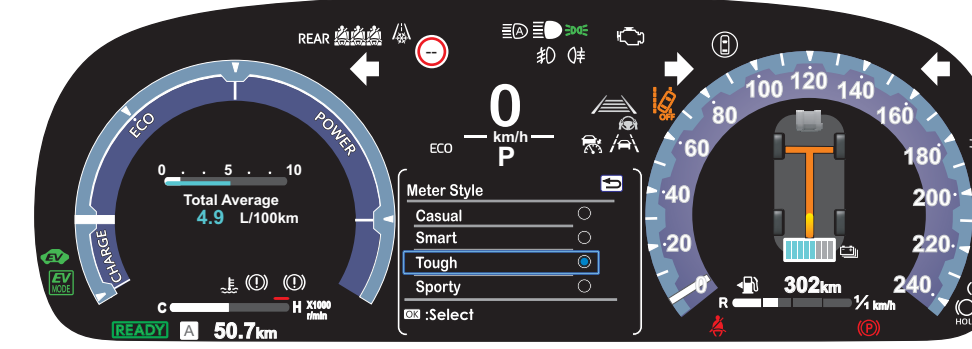

21

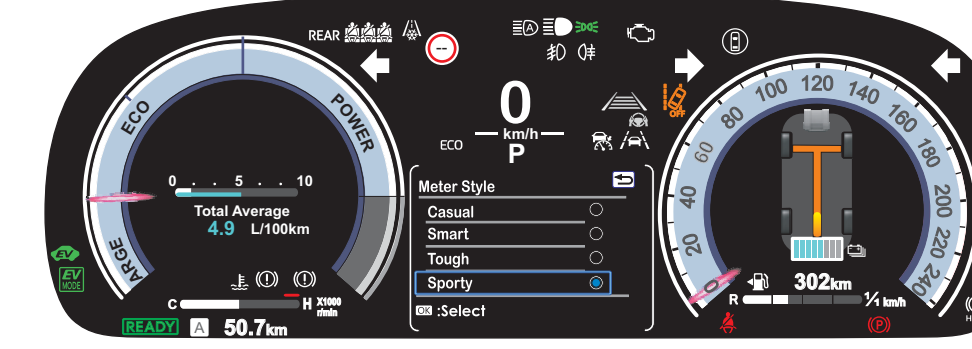



Dashboard instrument type customization

If you hold down the OK button for more than 2 sec. 2 round brackets appear which can be moved with the → or ← keys to choose the position between the 3 sectors.
 Once you have chosen the sector with the ↑ or ↓ keys you can choose what to see in that sector.
In the 1st and 3rd sectors it is possible to reset the Total average and TRIP A respectively

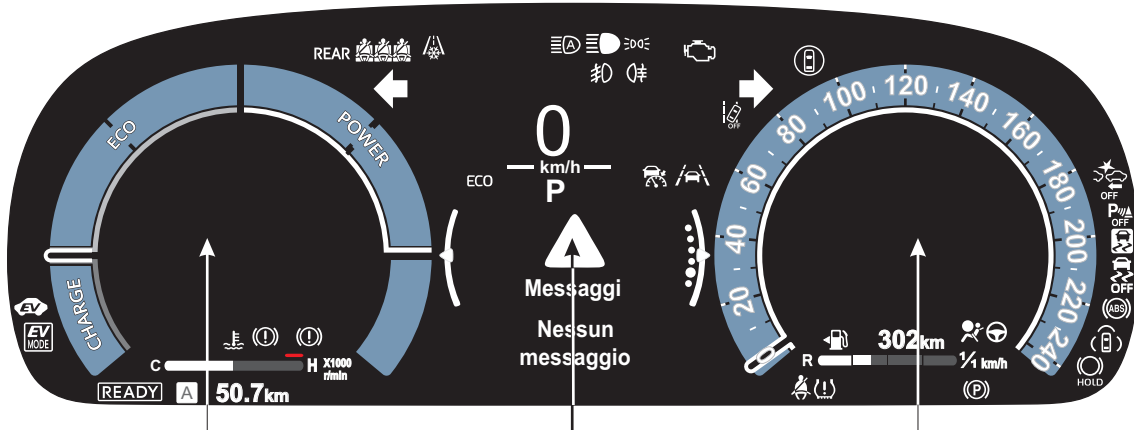

1° Sector

2° Sector

3° Sector

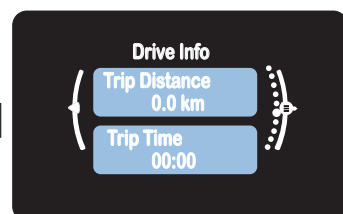
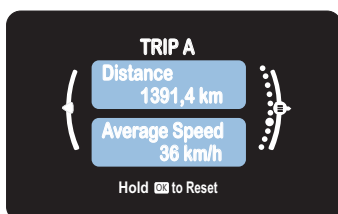
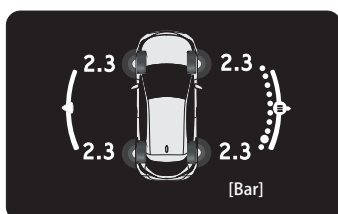
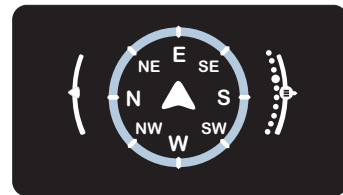
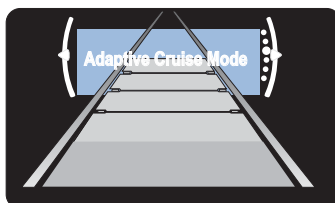
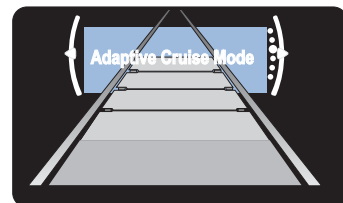
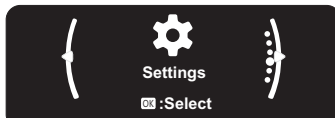
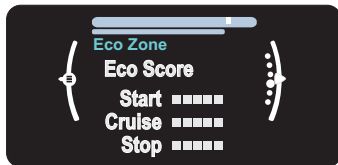
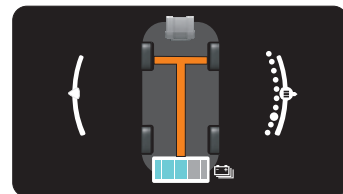
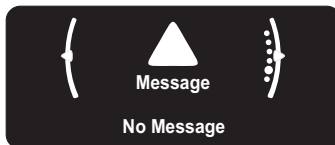
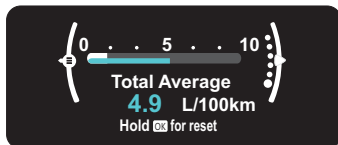



Dynamic radar cruise control

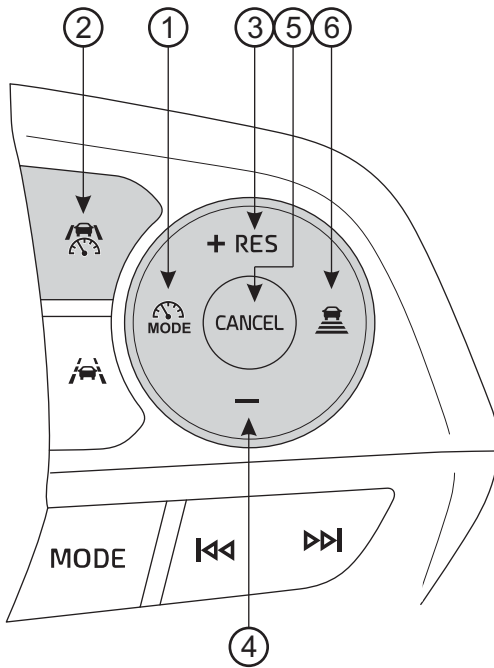

- ① Driving assist mode select switch
- ② Driving assist switch
- ③ "+" switch / "RES" switch
- ④ "-" switch
- ⑤ Cancel switch
- ⑥ Vehicle-to-vehicle distance switch

This dynamic radar cruise control detects the presence of vehicles ahead, determines the current vehicle-to-vehicle distance, and operates to maintain a suitable distance from the vehicle ahead.

The desired vehicle-to-vehicle distance can be set by operating the vehicle-to-vehicle distance switch ⑥. Use the dynamic radar cruise control only on highways and expressways.

Press button ① until selecting  and then accelerate to the desired speed (approximately 30 km/h or more), "Dynamic radar cruise control" appears in the central sector for a few seconds. Press button ② to confirm.

The green symbol  appears on the display with the green memorized speed above it and blue distance lines. The stored speed can be varied using the button ③ "+ RES" and button ④ "-"

To change the set vehicle speed, press the "+" or "-" switch until the desired speed is displayed.

The set vehicle speed will increase or decrease as follows:
 Short press adjustment: By 1 km/h (0.6 mph) or 1 mph (1.6 km/h) each time the switch is pressed
 Long press adjustment: Increases or decreases in 5 km/h (3.1 mph) or 5 mph (8 km/h) increments continuously while the switch is pressed and held

Canceling/resuming control

- 1 - Press the cancel switch or driving assist switch to cancel control.
Control will also be canceled if the brake pedal is depressed.
If the vehicle has been stopped by system control, depressing the brake pedal will not cancel control.
- 2 - Press the "RES" switch to resume control.



1st Message in the central sector



2nd Message in the central sector



Dynamic radar cruise control

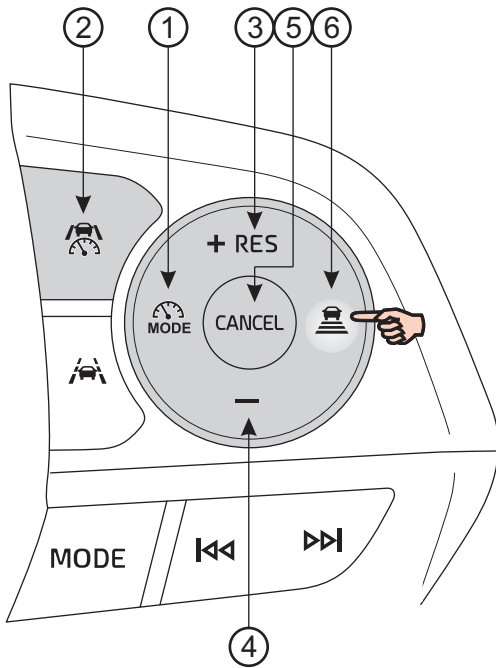

- ① Driving assist mode select switch
- ② Driving assist switch
- ③ "+" switch / "RES" switch
- ④ "-" switch
- ⑤ Cancel switch
- ⑥ Vehicle-to-vehicle distance switch

Changing the vehicle-to-vehicle distance

Each time the switch is pressed, the vehicle-to-vehicle distance setting will change as follows:
If a preceding vehicle is detected, the preceding vehicle mark will be displayed.

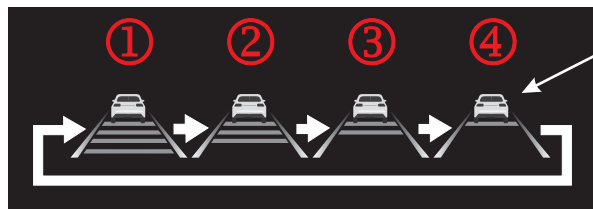

The actual vehicle-to-vehicle distance varies in accordance with the vehicle speed. Also, when the vehicle is stopped by system control, it will be stopped at a certain distance from the preceding vehicle, depending on the situation, regardless of the setting.

Illustration Number	Vehicle-to-vehicle distance	Approximate Distance (Vehicle Speed: 100 km/h [60 mph])
①	Extra long	Approximately 60 m (200 ft.)
②	Long	Approximately 45 m (145 ft.)
③	Medium	Approximately 30 m (100 ft.)
④	Short	Approximately 25 m (85 ft.)



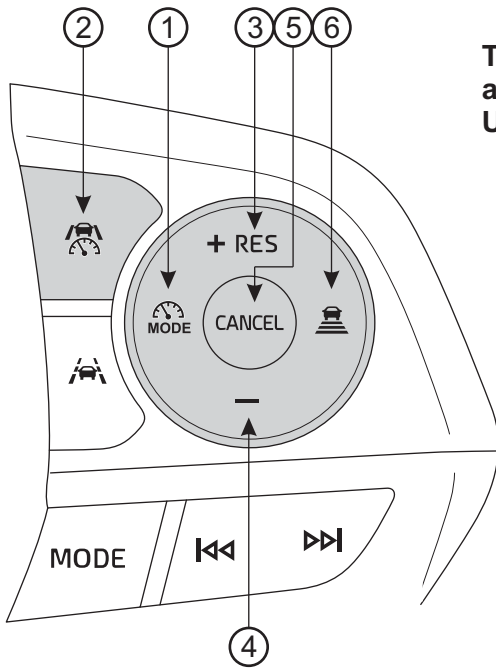

Cruise control



The vehicle can be driven at a set speed even if the accelerator pedal is not depressed.
Use the cruise control only on highways and expressways.

- ① Driving assist mode select switch
- ② Driving assist switch
- ③ "+" switch / "RES" switch
- ④ "-" switch
- ⑤ Cancel switch
- ⑥ Vehicle-to-vehicle distance switch

Press button ① until selecting  and then accelerate to the desired speed (approximately 30 km/h or more), "Cruise Mode" appears in the central sector for a few seconds. Press button ② to confirm.

The green symbol  appears on the display with the green memorized speed above it.
The stored speed can be varied using the button ③ "+ RES" and button ④ "-"
To change the set vehicle speed, press the "+" or "-" switch until the desired speed is displayed.
The set vehicle speed will increase or decrease as follows:
Short press adjustment: By 1 km/h (0.6 mph) or 1 mph (1.6 km/h) each time the switch is pressed.
Long press adjustment: Increases or decreases in 5 km/h (3.1 mph) or 5 mph (8 km/h) increments continuously while the switch is pressed and held

Canceling/resuming control

- 1 - Press the cancel switch or driving assist switch to cancel control.
Control will also be canceled if the brake pedal is depressed.
If the vehicle has been stopped by system control, depressing the brake pedal will not cancel control.
- 2 - Press the "RES" switch to resume control.



1st Message in the central sector



2nd Message in the central sector



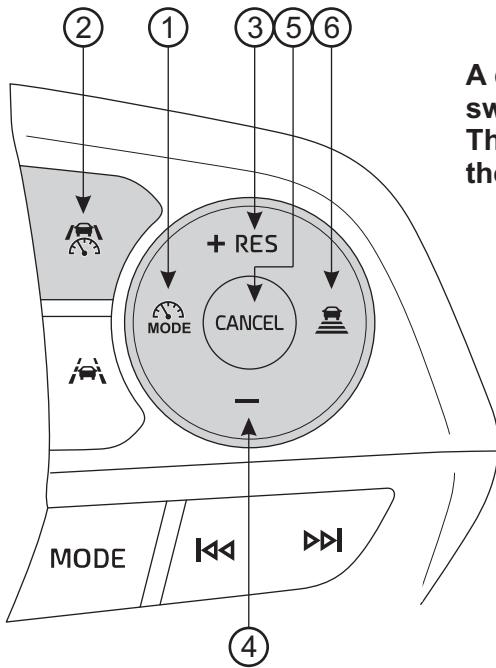

Speed limiter



A desired maximum speed can be set using the speed limiter switch. The speed limiter prevents the vehicle speed from exceeding the set speed.

- ① Driving assist mode select switch
- ② Driving assist switch
- ③ "+" switch / "RES" switch
- ④ "-" switch
- ⑤ Cancel switch
- ⑥ Vehicle-to-vehicle distance switch

Press button ① until selecting  and then accelerate to the desired speed (approximately 30 km/h or more), "Speed Limit Mode" appears in the central sector for a few seconds. Press button ② to confirm.

The green symbol  appears on the display with the green memorized speed above it. The stored speed can be varied using the button ③ "+ RES" and button ④ "-". To change the set vehicle speed, press the "+" or "-" switch until the desired speed is displayed. The set vehicle speed will increase or decrease as follows:
 Short press adjustment: By 1 km/h (0.6 mph) or 1 mph (1.6 km/h) each time the switch is pressed.
 Long press adjustment: Increases or decreases in 5 km/h (3.1 mph) or 5 mph (8 km/h) increments continuously while the switch is pressed and held

Canceling/resuming control

- 1 - Press the cancel switch or driving assist switch to cancel control. Control will also be canceled if the brake pedal is depressed. If the vehicle has been stopped by system control, depressing the brake pedal will not cancel control.
- 2 - Press the "RES" switch to resume control.



1st Message in the central sector



2nd Message in the central sector



LTA (Lane Tracing Assist)

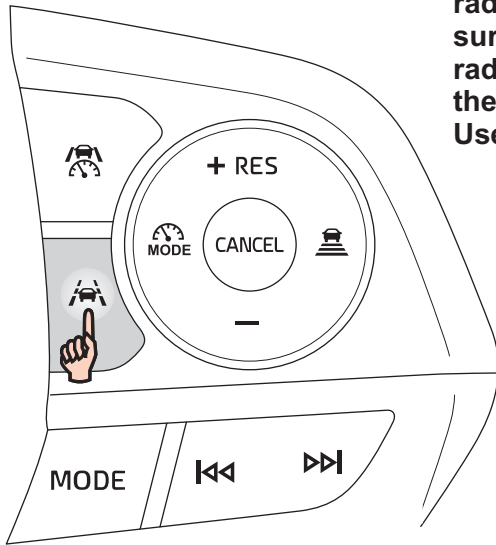









When driving on a road with clear lane lines with the dynamic radar cruise control operating, lane lines and preceding and surrounding vehicles are detected using the front camera and radar sensor, and the steering wheel is operated to maintain the vehicle's lane position.

Use this function only on highways and expressways.

The LTA will change between enabled/disabled each time the LTA switch  is pressed. When the LTA is enabled, the LTA indicator will illuminate.



The operating state of the LTA system is indicated.

Indicator	Lane display	Steering icon	Situation
 White	 Grey/White	 Grey	LTA is on standby
 Green	 Green	 Green	LTA is operating
 Orange Flashing	 Orange Flashing	 Green	The vehicle is departing the lane toward the side which the lane display is flashing